

Article number: 021816011204

Description: Clamp with bracket and rubber
SPGU 6011. 204/30 SK

Measures

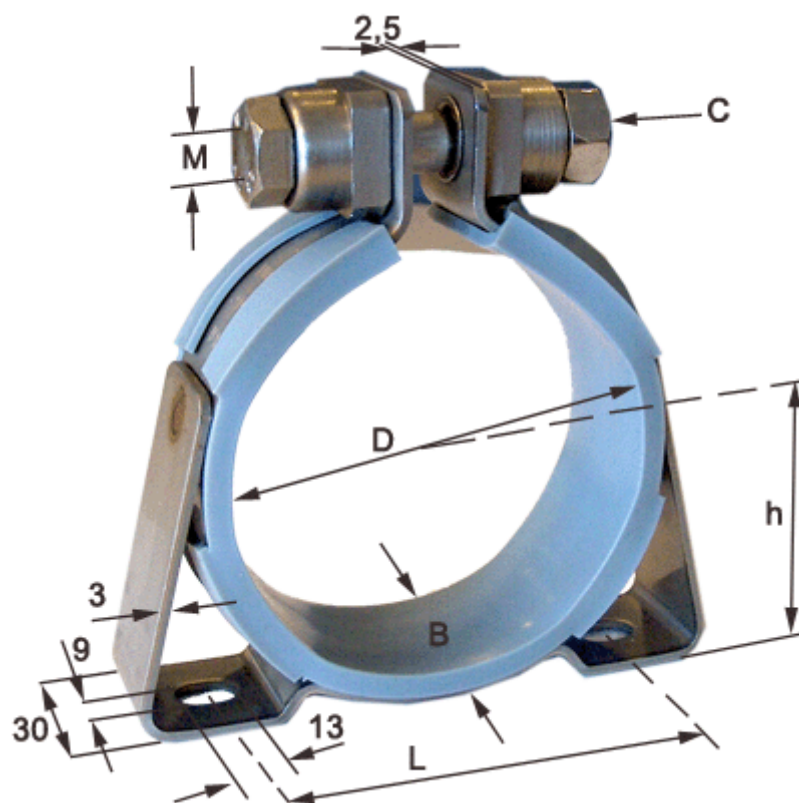

C (screw type) = SK hexagon screw

Diameter D = 204

h = 110

L = 212

Width B = 30